

NEW

JINFER

# ALU<sup>36</sup> SERIES

Aluminum Base Shoe Glass Railing System





# Build Your Glass Railing System

Glass Thickness  
1/2" - 27/32"  
(12 - 21.52mm)

Black Matte Coating

Satin Anodized Aluminum

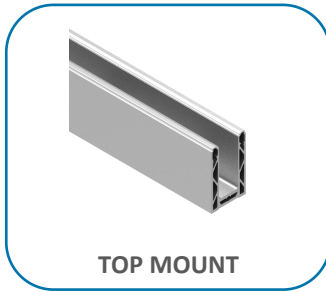

TOP MOUNT



TOP MOUNT  
CORNER



TOP MOUNT  
CLADDING

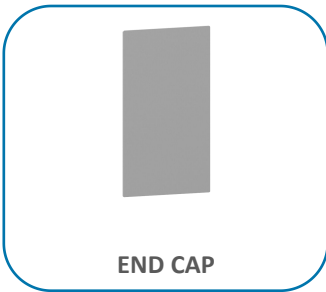

END CAP

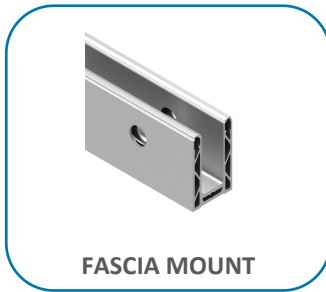

FASCIA MOUNT



FASCIA MOUNT  
CLADDING



PIN



WEDGE & RUBBER

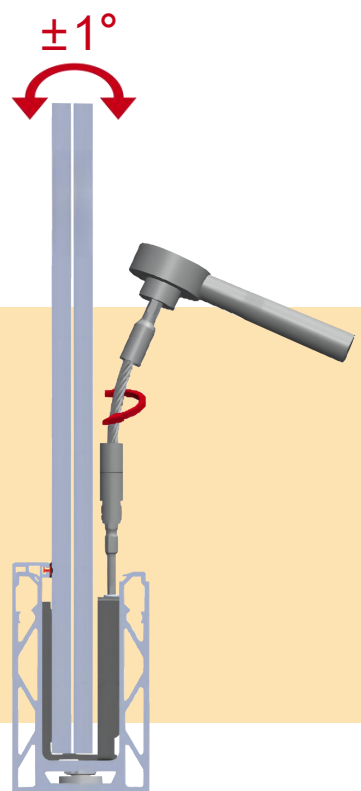
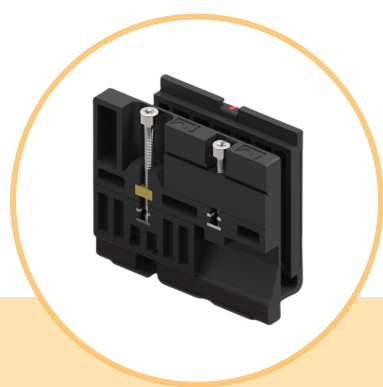

The glass angle can be adjusted by adjusting the two screws on the wedge. No need to remove glass, safe and easy.

## Tilt for Glass Alignment

- Customized for Different Sizes of Glass

GLASS (mm)	WEDGE	BUCKLE BAR	RUBBER (outside)	RUBBER (inside)
12/12.76/13.52				
15				
16.76/17.52				
19				
20.76/21.52				

- Recommend Fixing for Different Application

APPLICATION	TYPE OF FIXING	SIZE OF FIXING (adjustable to actual floor thickness)	PICTURE
Brick Wall/ Concrete Floor	Hexagon Head Expansion Screws	M8×100	
Wooden Floor	Hexagon Head Wood Screws	ST12×100	
Metal Frame	DIN933 Hexagon Head Bolts	M12×100	

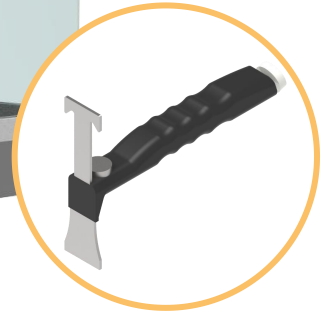
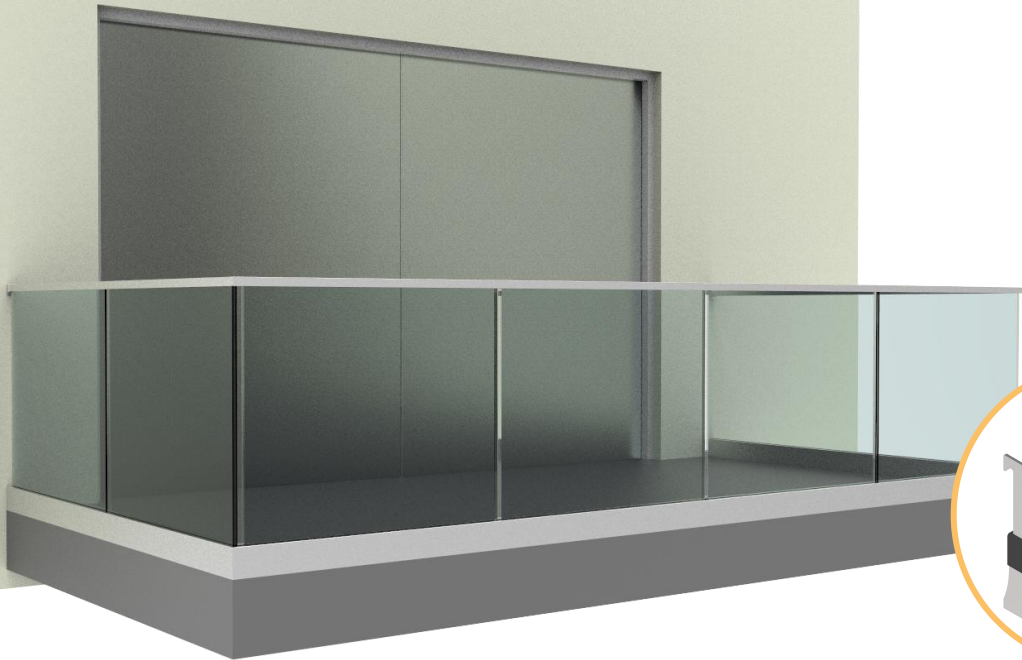

## Complete System

JINFER offers a complete system of aluminum base shoe glass railing, including handrail systems and installation tools.

## Easy Installation

Without the bulkiness of traditional aluminum base shoe, JINFER ALU<sup>36</sup> offers a simpler installation experience.

## Quick Selection

No need to think about every detail. Provide the installation environment, JINFER ALU<sup>36</sup> is ready to go.

# JINFER RAILING

---

No.6 Shandong Road Qingdao China 266000

TEL: +86 532 8386 0958

E-mail: sales@jinferrailingus.com

www.jinferrailingus.com

**JINFER**  
BALUSTRADES & RAILINGS



Find More



YouTube