

Step 1: Drill holes in the Wall (according to your drawing)

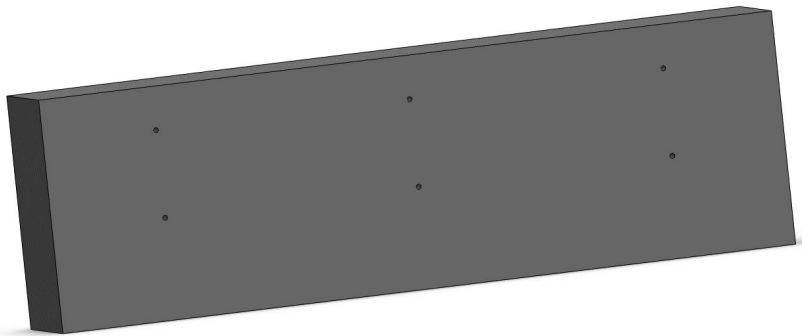

Step 2: Install the Pin and the Fixed Base

The fixed base could adjust the spacing between each other through the elliptical hole

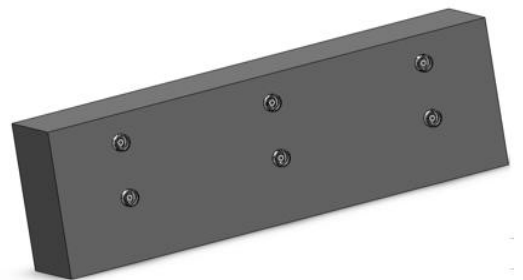
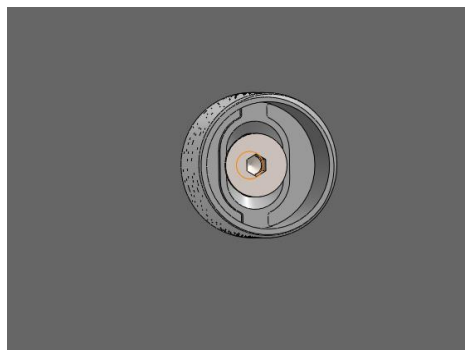
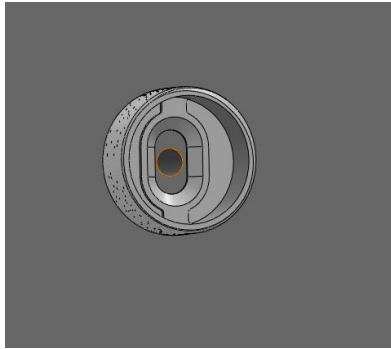

Step3: Install the body of Standoff and adjust leveled, then install the T-profile Rubber

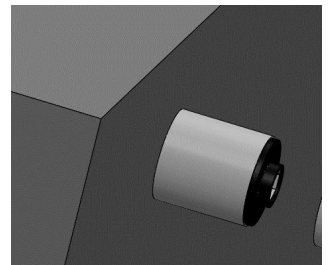
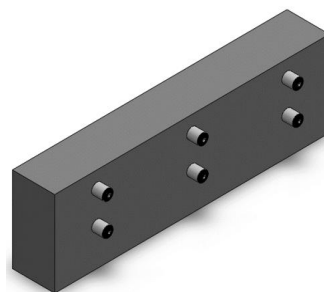
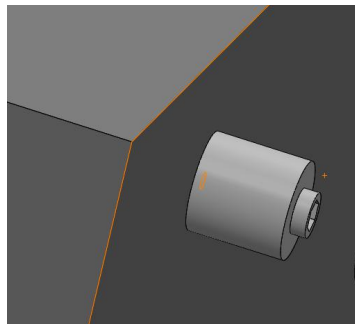
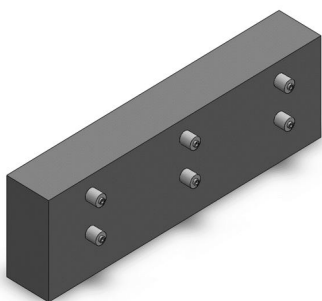

Step 4: Install the Glass

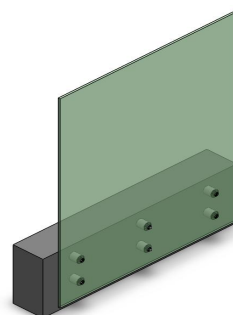
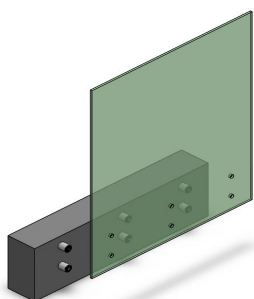

Step 5: Install the Standoff Cap and Tighten

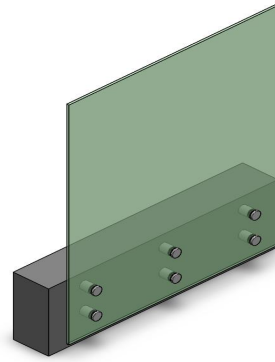

JINFER QINGDAO JINFER INTERNATIONAL CO.,LTD.

Add: No.6th Shandong Road, Qingdao China 266000

Tel: +86 532 8386 0958

Email: sales@jinferrailing.com

www.jinferrailing.com